

Building Nest Structures, Feeders, and Photo Blinds for North Dakota Wildlife

by
Chris Grondahl
and
John Dockter

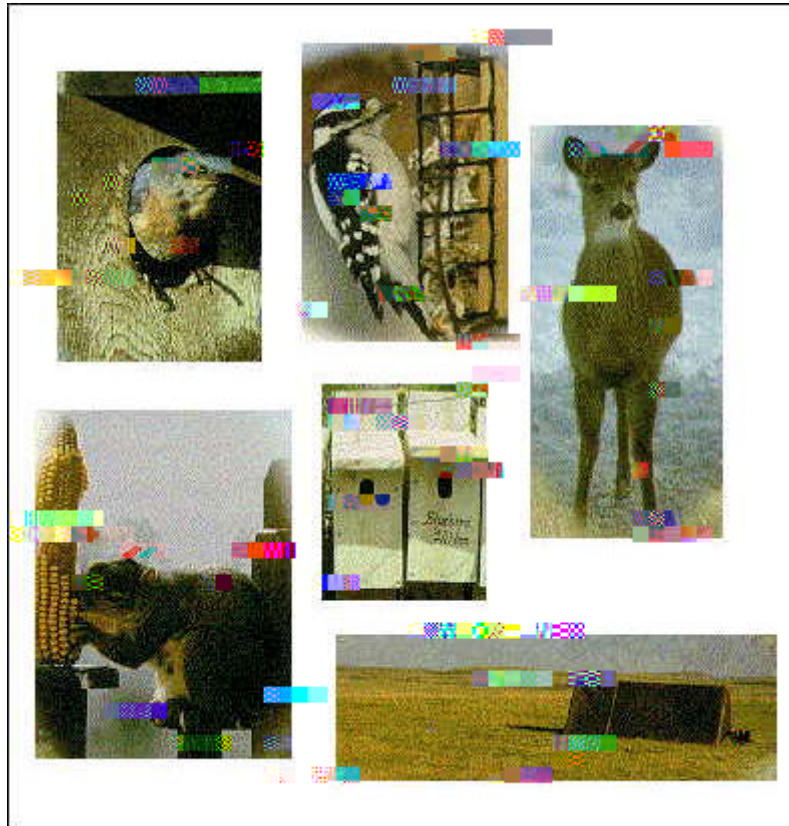

State Game and Fish Department
100 North Bismarck Expressway
Bismarck, North Dakota 58501-5095

Table of Contents

[Introduction](#)

[Section 1 -- Nest Boxes and Nesting Platforms](#)

- [House Wren, Black-capped Chickadee, White-breasted Nuthatch](#)
- [Tree Swallow and Eastern Bluebird](#)
- [Peterson Bluebird House](#)
- [American Robin and Barn Swallow](#)
- [Purple Martin House](#)
- [Northern Flicker Nest Box](#)
- [American Kestrel, Northern Screech-owl, Gray Squirrel, Red Squirrel, and Fox Squirrel Nest Box](#)
- [Burrowing Owl Nest Tunnel](#)
- [Small Bat House](#)
- [Johnson Bat House](#)
- [Wood Duck and Hooded Merganser Nest Box](#)
- [Raccoon and Common Merganser Nest Box](#)
- [Entrance Hole Sizes for Songbird, Woodpecker, and Squirrel Nest Boxes](#)
- [Canada Goose Nest Platform, Turtle and Duck Loafing Platform](#)
- [Canada Goose Nest Tub](#)
- [Culvert Nest Structure](#)
- [Mallard Nest Basket](#)
- [Hen House](#)
- [Mourning Dove Nest Basket](#)
- [Great Blue Heron Nest Platform](#)
- [Entrance Hole Sizes for Duck, Merganser, and Raccoon Nest Boxes](#)

[Section 2 -- Feeders](#)

- [2-Liter Plastic Soda Bottle Bird Feeder](#)
- [Milk Carton Feeder](#)
- [Large Self-Feeder](#)
- [Linda Tray Feeder](#)
- [Hardware Cloth Suet Feeder](#)
- [Dowel Suet Feeder](#)
- [Barrel Feeder for Wildlife](#)

[Section 3 -- Predator Guards](#)

[Section 4 -- Wildlife Viewing and Photography Blinds](#)

- [Low-Profile A-Frame Blind](#)
- [Modified Portable Fishhouse-Type Blind](#)

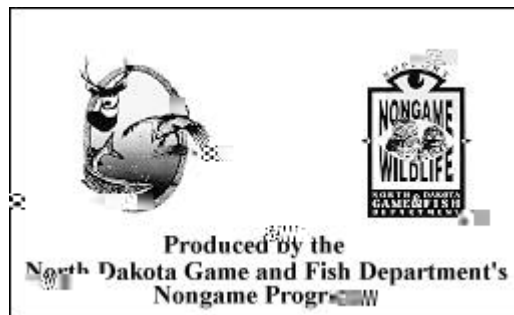

Credits

Thanks to Carrol L. Henderson of the Minnesota DNR for contributing artwork from *Woodworking for Wildlife*. Thanks to Linda Roeder for organization and layout of this publication.

Photos

by Chris Grondahl and Harold Umber

Introduction

Providing nesting areas, feeding, and watching wildlife are becoming increasingly popular sports in North Dakota. These activities generate about 18 million dollars annually to our state. More importantly, these pastimes provide hours of relaxation, entertainment, and enjoyment for both young and old alike.

This publication introduces some types of nest structures, feeders, and photo blinds which can be constructed in your home at a minimal expense.

There are four sections to this publication. The first covers nest boxes and platforms. These structures are meant to enhance existing habitat or provide a nest structure where none presently exists. This does not mean that natural habitat is not important. Dead and dying trees which provide nesting cavities are still the best type of habitat available.

The second section describes wildlife feeders. Feeding birds and mammals in the winter can be good for both you and wildlife. First, it provides you a pastime and viewing opportunity during the cold winter months. Secondly, wildlife may have difficulty finding adequate food and this additional source can help them survive the winter. Remember, planting a crop for feed is just as good, or better, than grain in a feeder.

Section three is a short description of predator guards which are very important additions to any wooden support post.

The final section describes two types of homemade photo blinds which can be made with minimal effort or dollars spent. If you've never tried a photo blind, you may be surprised at the results.

Nest Boxes and Nesting Platforms

General Information for Nest Boxes and Nesting Platforms

Providing nesting areas for wildlife is a popular and growing hobby for many North Dakotans. Building houses according to the proper specifications, placing them in the right habitat, and maintaining them can benefit both bird and mammal populations. If they are not monitored for detrimental species such as the house sparrow, they may actually do more harm than good.

It is important to realize that not all birds and mammals nest in cavities. Many birds, like the American robin or meadowlark, either build cupshaped nests in trees or nest on the ground. The nest box plans that are found in this publication are specific to wildlife that utilize a cavity, either within a dead or dying tree or a man-made structure such as a nest box.

Cavity nesting birds will accept any kind of nest box that they can enter. Before deciding on what kind of nest box to build, there are considerations which should be taken--the size of the entrance hole, interior dimensions, proper ventilation, and the capability to open the nest box for monitoring and cleaning. Do not construct a box for "birds" in general as most species require different sized houses and entrance holes. The following guidance and construction plans will provide specific plans for most North Dakota species.

For all practical purposes, wood is the only appropriate building material to use. Wood is a natural material with good insulating properties. Plastic and metal often overheat. Green "pressure-treated" lumber is impregnated with copper arsenate as a preservative. If the chemical is not applied perfectly, the wood is toxic to birds and humans. Exterior grade plywood contains dangerously high levels of formaldehyde and therefore is also not the best choice. The best woods to use are rough cut cedar or redwood. They naturally resist deterioration when exposed to sun and rain and the weathered look is inconspicuous and attractive.

Never paint or stain the inside of a nest box. If you want to paint the exterior, close up the box and paint only what you can see. Use an exterior grade latex paint and give the top a second coat. Choose a light shade which reflects most heat or a natural color such as green, tan, or gray. A heavy grade of linseed oil stain works well also. Houses that blend in with their surroundings are more appealing than brightly painted boxes and less likely to draw the attention of human vandals.

Nest boxes can be mounted in several ways. They may be attached to existing wood or metal fence posts, power or telephone poles, existing trees, or on wood or metal posts or pieces of pipe used specifically for this purpose. Utility poles are often suitable for mounting nest boxes; however, permission should be obtained from the utility companies before this is done. Discretion should also be used before mounting to trees. Do not place bird boxes designed for bluebirds on trees because this invites competition from too many other species.

Predator-proofing should, be considered for all bird nest boxes17 Tw (ma (PrsBnr oITj PrsBnr 7 Tw -13.92 5.0

Do not put perches on any bird houses. Only the unwanted house sparrows and starlings prefer perches. If house sparrows or starlings begin nesting in a bird house tear out the nest material as these species are not protected by state or federal law. Nests may need to be removed numerous times before these birds abandon their efforts.

House Wren*, Black-capped Chickadee*,
White-breasted Nuthatch



Note: Entrance hole diameter is 1 1/8".

(An entrance hole diameter of 1 1/4" is needed for the white-breasted nuthatch.)

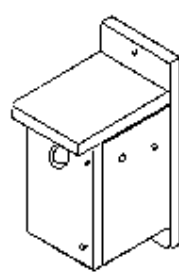
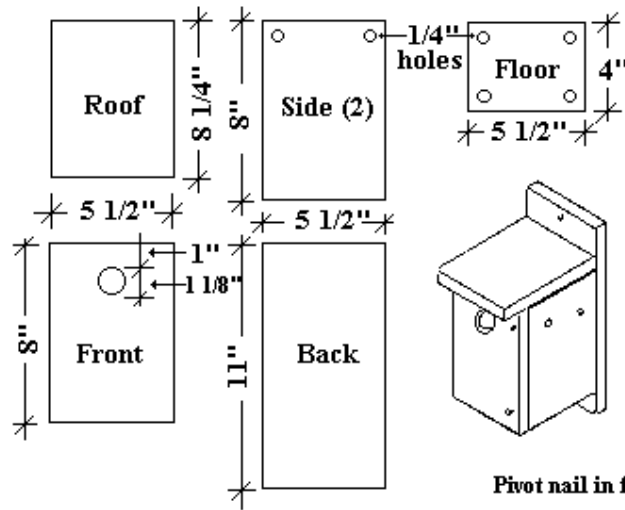

Pivot nail in front.

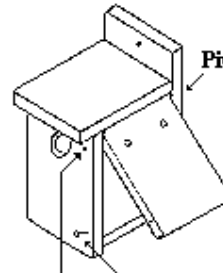

Pivot nail in back.

Use one nail or screw at bottom to hold door closed.

Peterson Bluebird House
(continued)

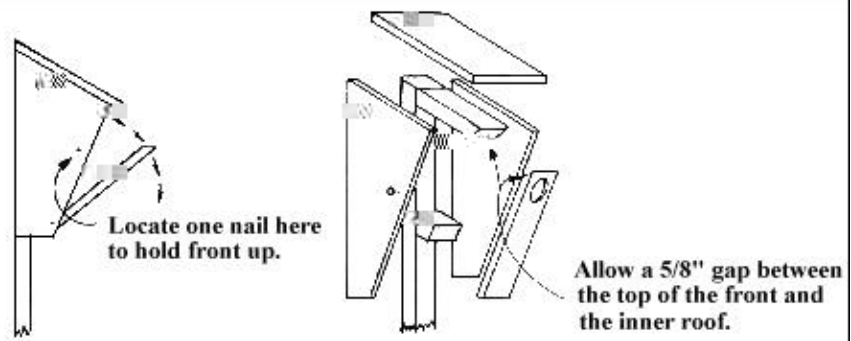

A. The Peterson house has seven parts and is assembled in this order:

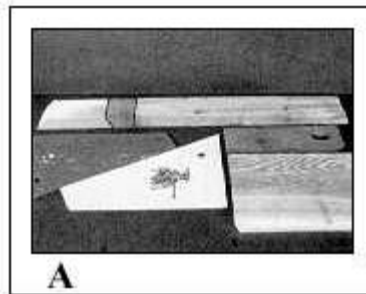

B. The inner roof is toe-nailed to the back.

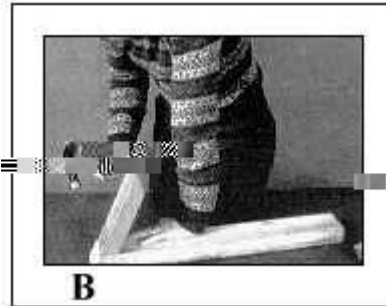

C. Then the floor is toe-nailed to the back.

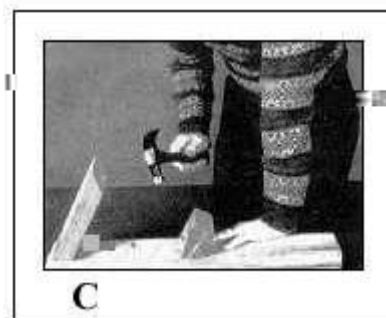

D. Third, one side is nailed to the resulting frame.

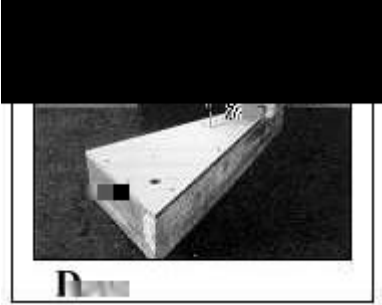

E.

American Robin and Barn Swallow

American Robin is one of the most commonly known birds in the United States and is a joy to welcome back in the spring. A shelf as described below can be placed on the wall near a window where the birds can be observed throughout the nesting season or to a tree trunk or post 6-10 feet above the ground. Barn Swallows will also utilize this shelf structure and you may be encouraged to nest away from a doorway or other convenient location if presented with this opportunity.



the
bird
des
wh
sea
Ba
ma
inc

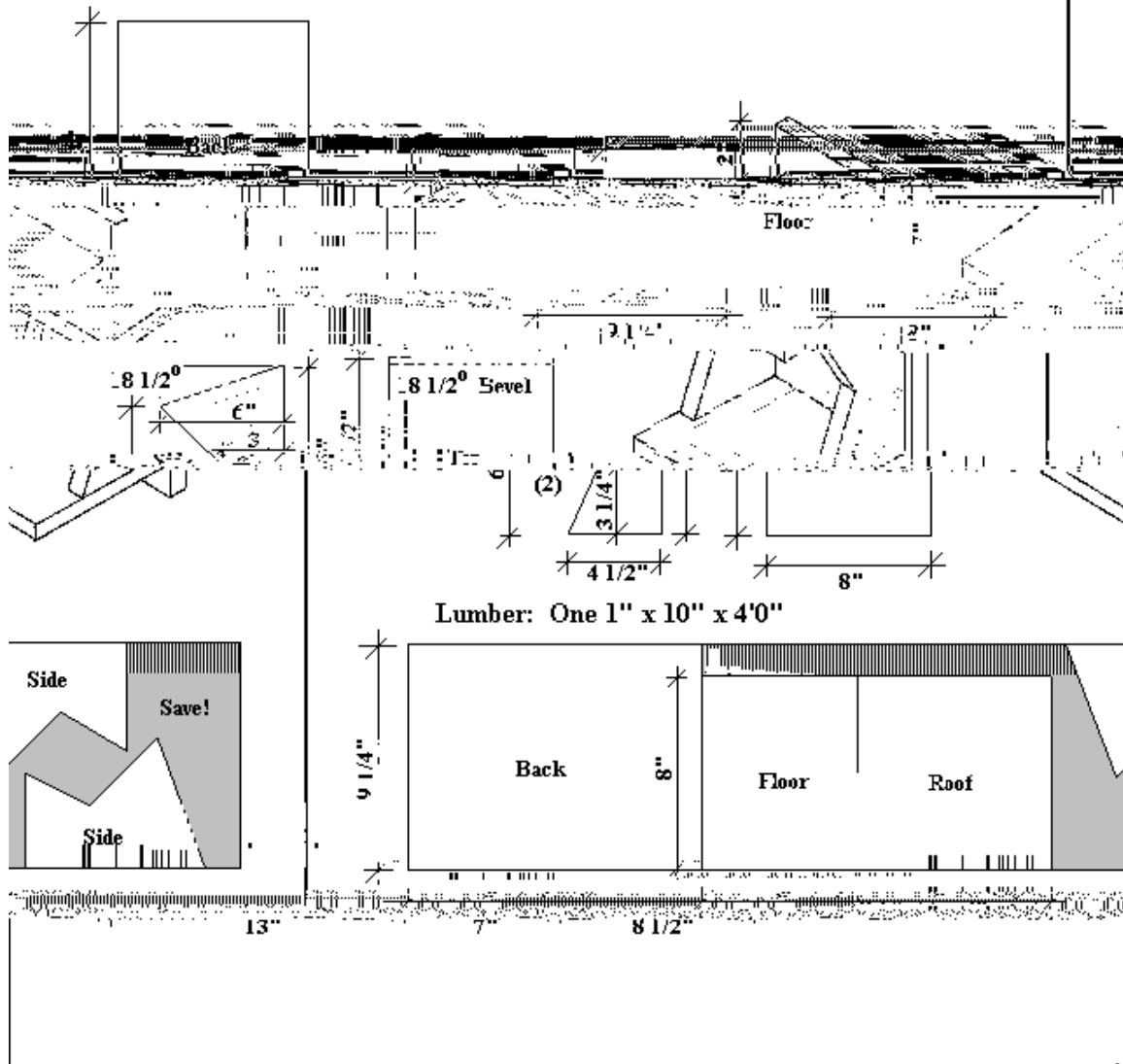

INSTRUCTION

house from one sheet of plywood.

CONSTRUCTION

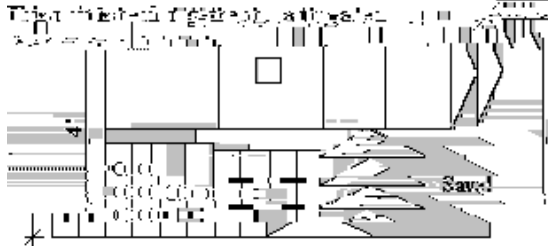

Layout pattern.



Expanded view of martin house. A threaded rod inserts through the base and up through the chimney.

Entrance hole diameter: 2 1/4"



Locate 5/8" ventilation holes 1" below roof edge on sides.



*For sides, measurement from floor to center of entrance holes = 2 1/8"

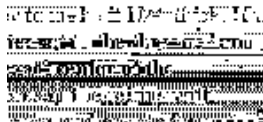
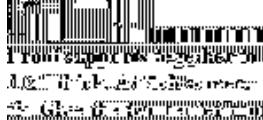

V-notch on end to fit roof. Have it extend 2 1/2" above roof peak. Drill 1/4" hole in chimney and roof for rod. Nail chimney in place. Insert rod and tighten up.

8. Drill hole in top of pole to accommodate nut on lower end of threaded rod.

9. Use 1/2" diameter maple dowels to make a fence about 2" high on each balcony. Pieces of wood 1" x 1" x 3" may be used as the corner posts of this railing.

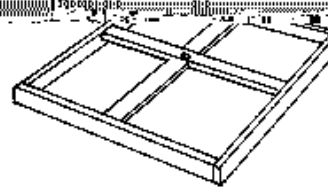

base frame through the center of the chimney.

1. Mark all pieces on plywood sheet, then cut them out. Make four 1" x 1" x 5 1/8" corner blocks and eight 1" x 1" x 2" blocks of position the same.

2. Cut out and assemble base from 1" x 2". Use 7d galvanized siding nails. Attach floor piece to base with glue and 1" or 1 1/4" nails.

3. Assemble the sides, alternating three hole and one hole pieces. Use glue and 1" nails or 3/4" #6 flat head wood screws. Use three at each end of each piece.

4. Position first-story sides on base piece. Mark position for each 1" x 1" x 2" block to hold side in position. Attach blocks to floor with glue and two 1" nails or 3/4" #6 flat head wood screws. Place unattached sides in

ceiling and mark for the location of 1" x 1" x 2" blocks near corners on the underside. Attach the blocks.

formal beads. Position and tie...

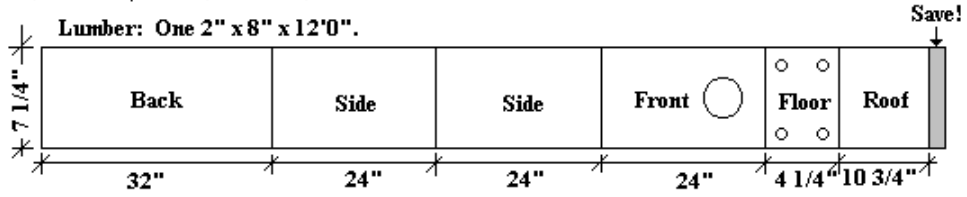
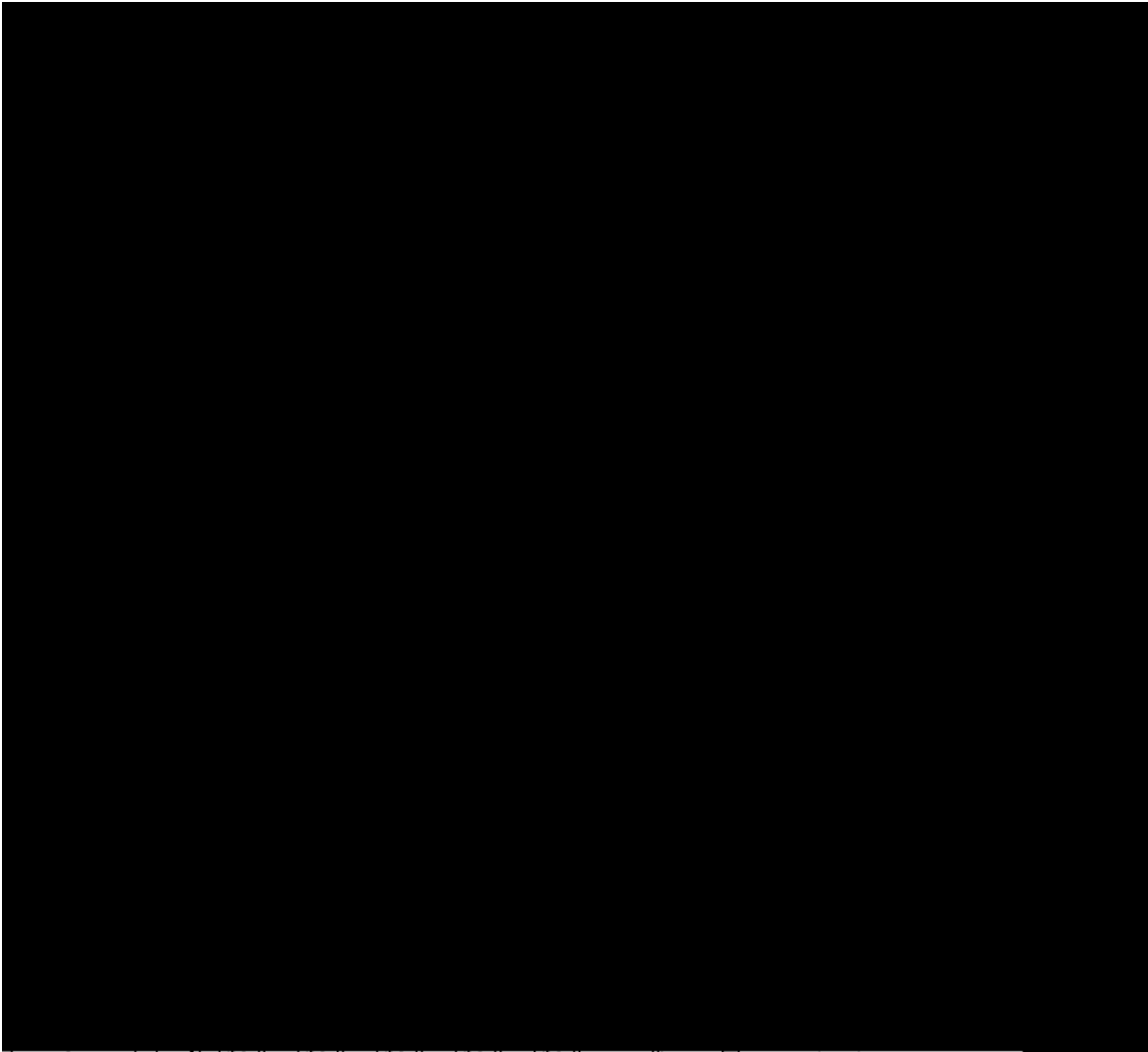

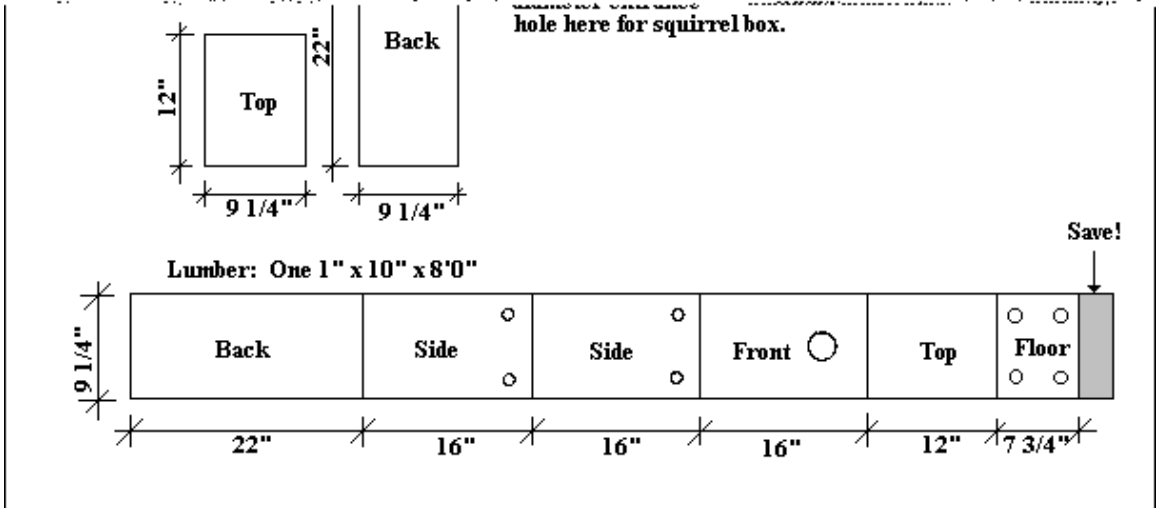
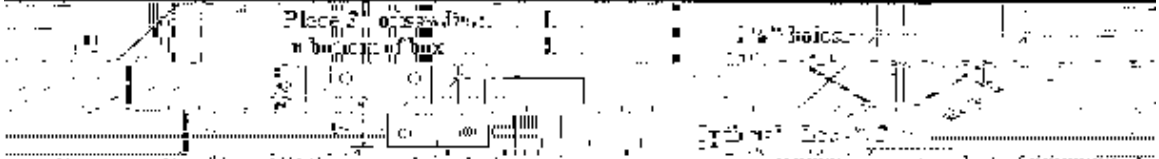
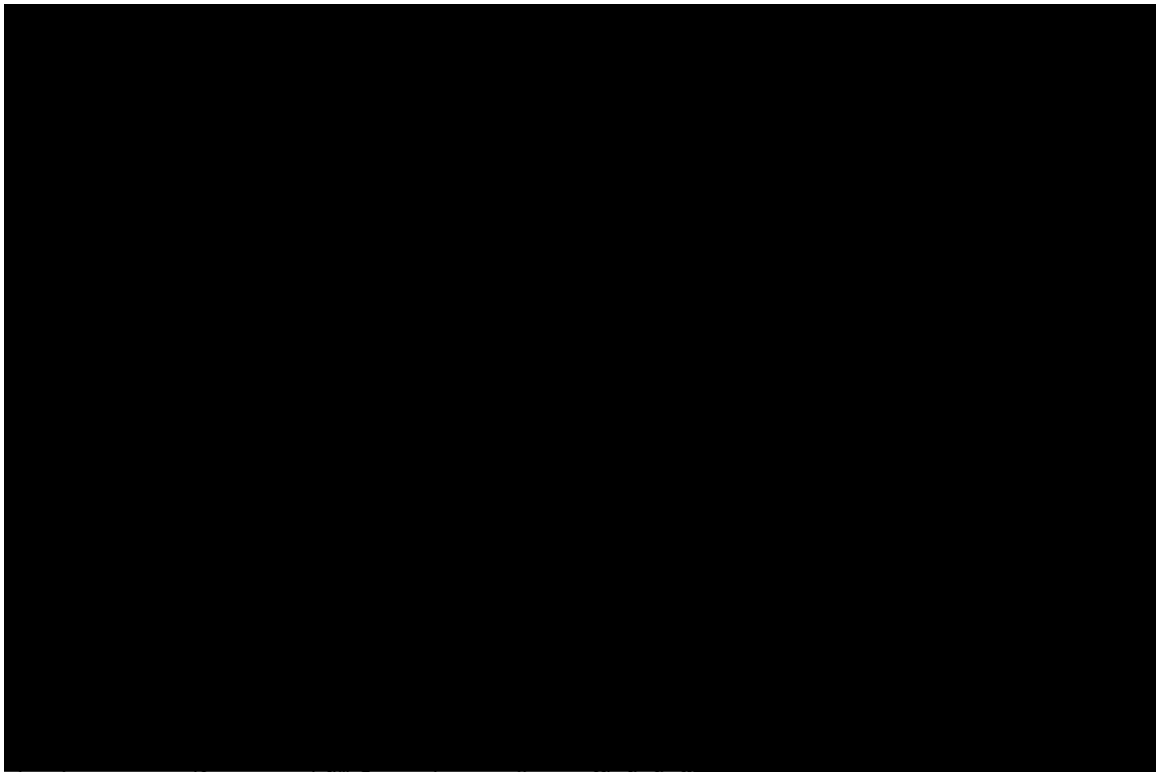

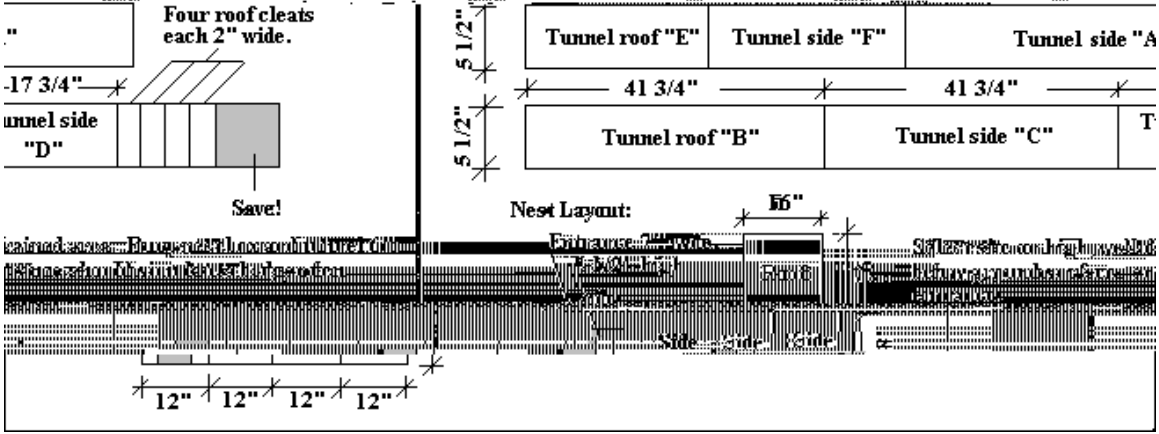
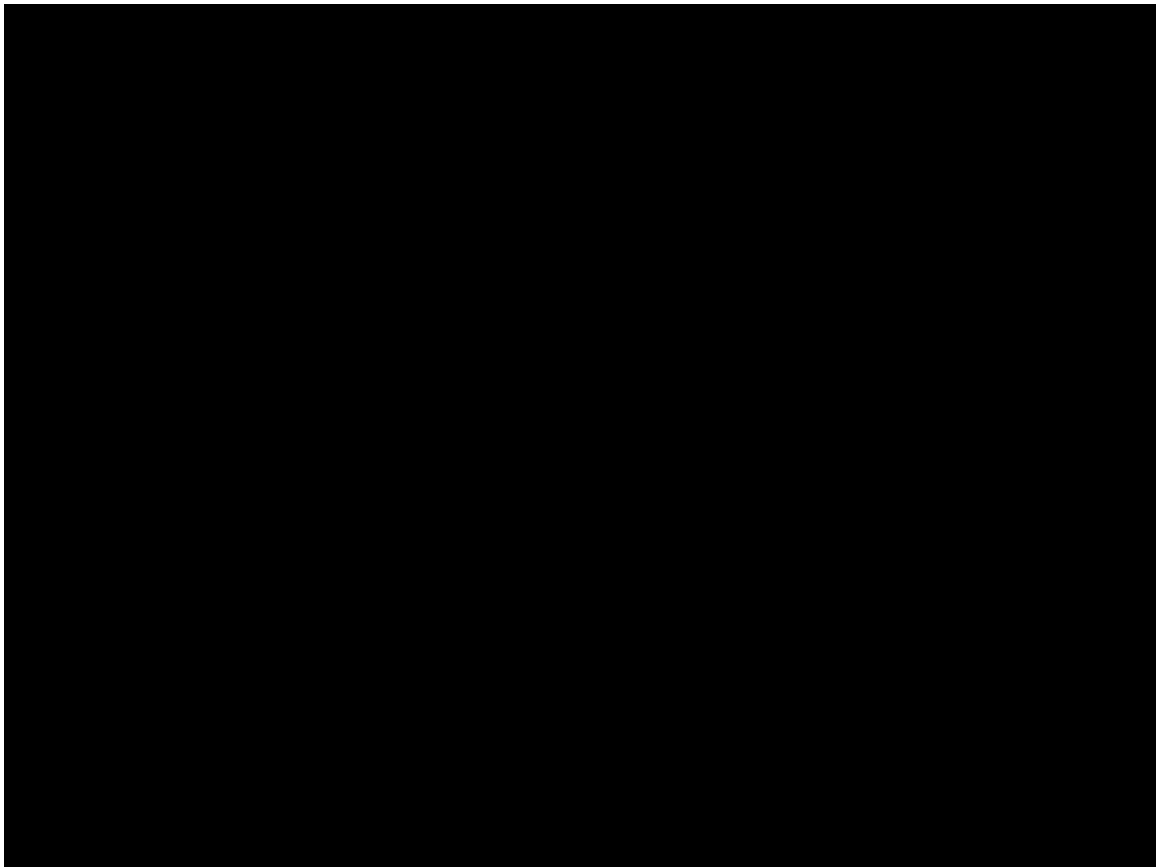

Small Bat House

Nine species of bats can be found in North Dakota but the little brown bat is the most common. Bats are insect eaters and may eat over 1,000 insects each evening. They require a warm, moist environment which reaches 80-90 degrees during the daytime. This can be achieved by covering part of the house with tarpaper. Painting with black may also help. Houses should be



akes, or marshy areas where insect populations are high. Nest boxes should be about 12-15 feet above the ground.



ivers, I should l

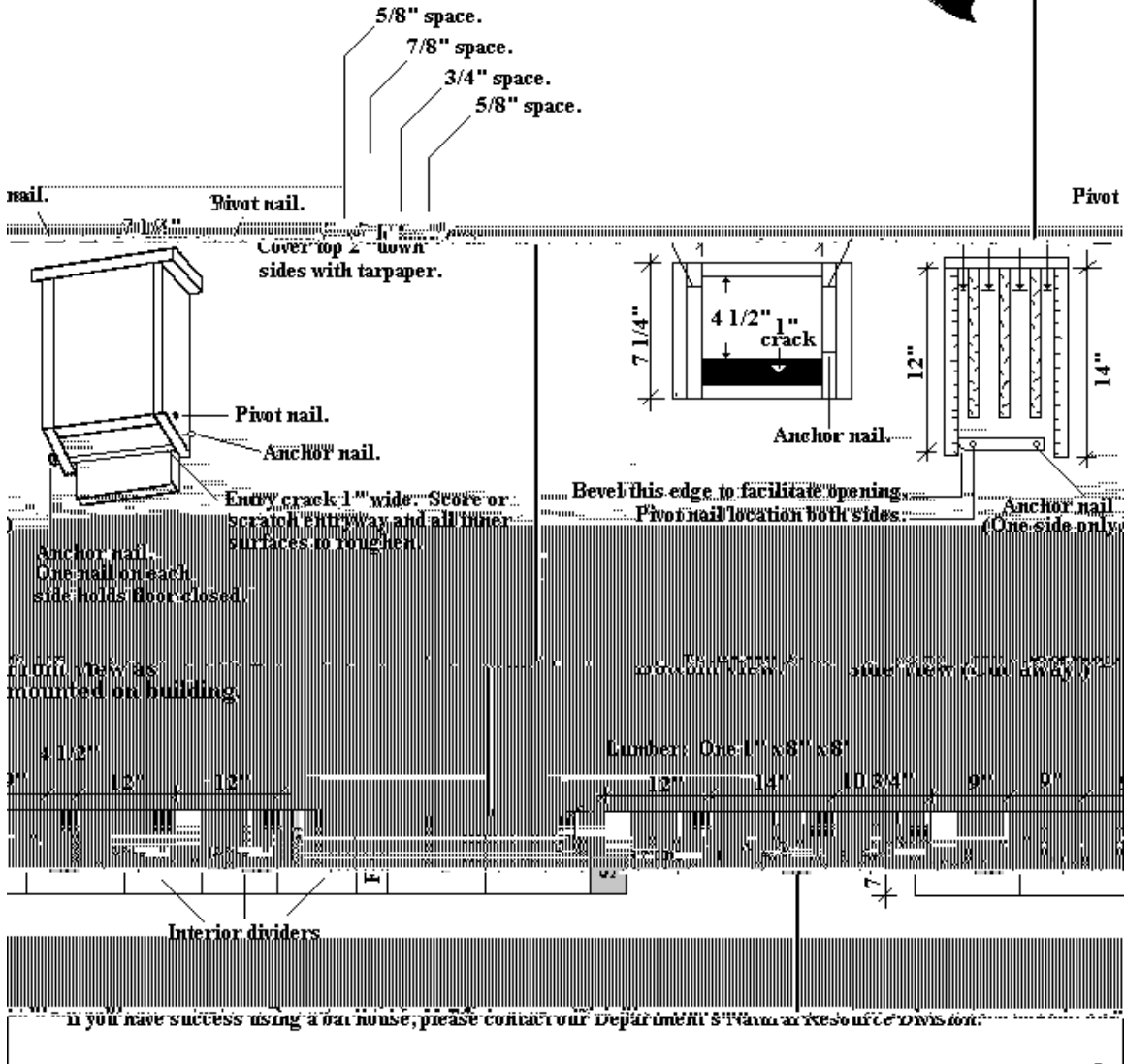

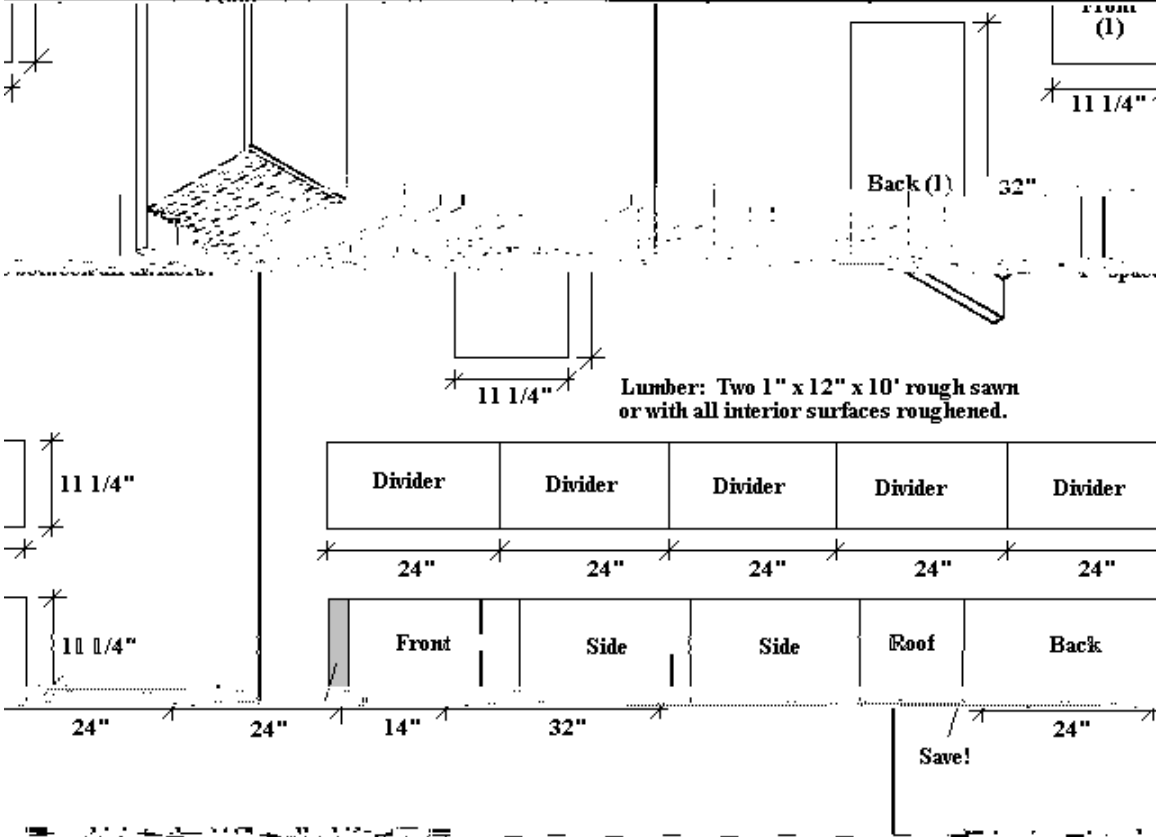

tight fitting. Divider boards are spaced 1 inch apart.

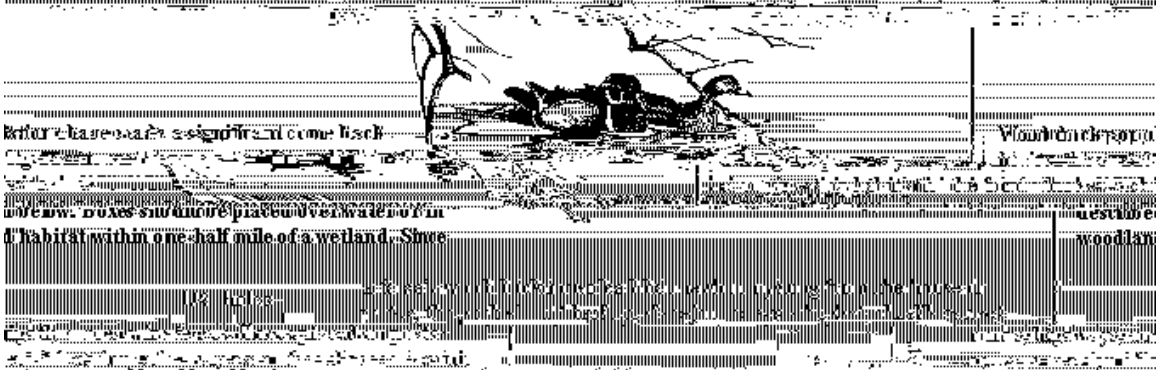

Before base can be assembled, come back to the new holes should be placed over water or in a habitat within one-half mile of a wetland. Shows

woodland

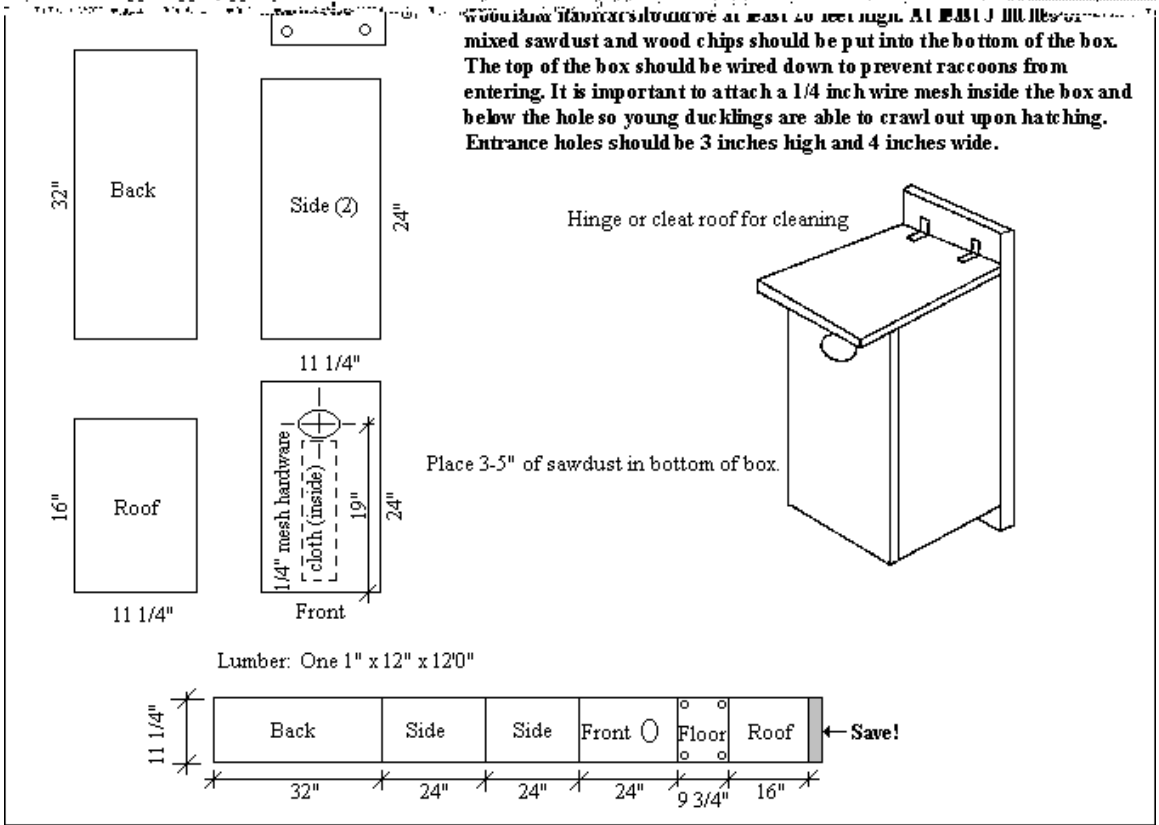

Entrance Hole Sizes for Songbird, Woodpecker, and

Cardinal Nest Boxes

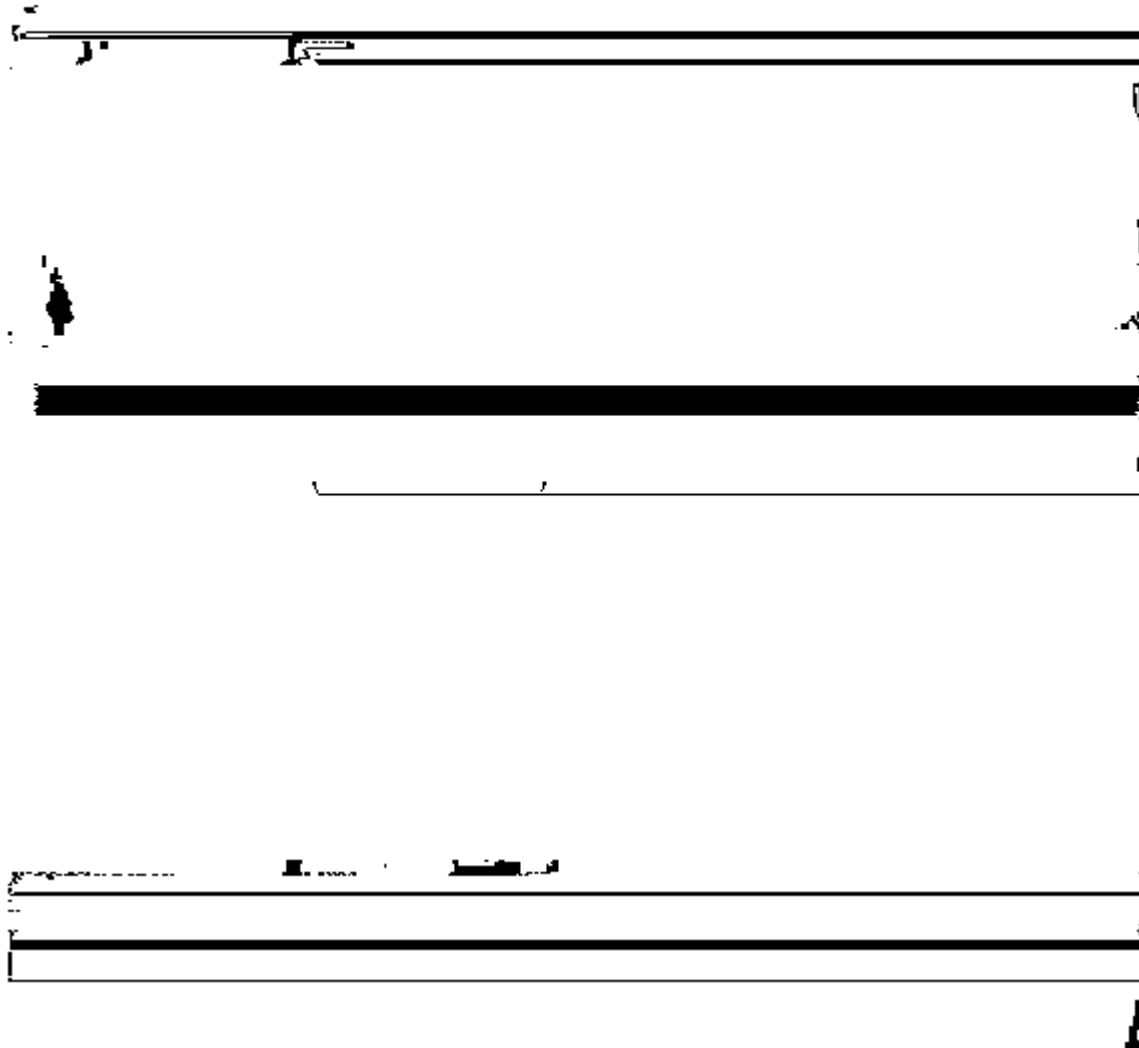

Canada Goose Nest Platform
Turtle and Duck Loafing Platform

The giant Canada goose has made a tremendous comeback in North Dakota in the

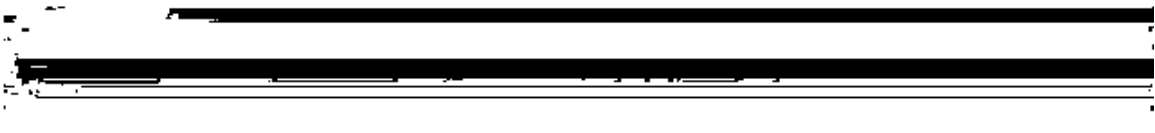
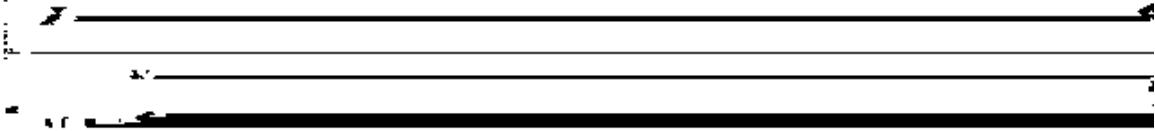

Nest Tub

A structure which has also proven to be effective in attracting Canada geese is the fiberglass nest tub. These tubs measure 32 inches in diameter and have an 8" sidewall with an additional 2" drop in the bottom of the tub. These structures are mounted on a 9 foot pipe after the pipe has been driven into the bottom of the wetland. The best time to erect these structures is during the winter when you can work on top of the ice.

Select a location where the water will be from 1 to 3 feet deep and, if possible, at least 50 feet from the shore. A stand of emergent vegetation such as bulrush is an excellent location. The pipe should extend out of the water at least 3 feet. Choose an area along the north or west shore or in a protected bay where it will be less apt to get pushed over by the ice action in the spring. More than one structure can be placed in a wetland as long as they are at least 200 yards apart. It also helps if the view from one to the other is obstructed. Nesting material should be placed in the tub by March 1 as Canada geese are early nesters. Put enough material into the tub so that it extends above the top.

Geese will not always find the tub the first year--do not be discouraged. Check to make sure the tub is filled with nesting material annually and that the tub has not been pushed over by ice.

Fiberglass baskets (tubs) for elevated goose nesting structures:

Fiberglass Unlimited, Inc.
South Highway 81
PO Box 1297
Watertown, South Dakota 57201-1297

00 Raven g TD -0.0355 tinako
PO Box 1297



100

Location

Culverts are best suited for Type IV wetlands, followed by larger Type IIIs and sheltered areas of Type Vs. Culverts should be placed within six feet of emergent vegetation in a water depth of approximately 18 inches in the spring. One structure per 10 to 20 acres is a good goal and there should never be more than one per wetland acre. Areas with nearby trees should be avoided because they provide hunting perches for raptors and crows.

Installation

(Culverts of 1.5-1.8 m in height are preferable.) A culvert can be either installed in a dry wetland or through the ice. Installation in a dry wetland is much easier and less hazardous than through the ice. To install in a dry wetland, scrape a depression in the wetland bottom with a loader bucket. Using the bucket, push down and square the culvert in the depression. While installing through the ice, use good judgment as to what the ice conditions are. If ice is thick enough to support the equipment, start by cutting a hole in the ice. Cutting a hole in the middle of the circle of ice will make it easier to lift out. Once the ice is removed, push the culvert down into the mud and level it. Try to get the culvert into solid (but not frozen) bottom substrate.

Filling the Culvert

Culverts should be filled with soil suitable for plant growth. Rock or gravel are not acceptable fill material because they do not allow moisture to reach growing plants. The soil will settle and the culverts must be revisited to replenish the settled soil. The soil can settle as much as two feet, making it impossible for ducklings and goslings to escape. Filling the culvert with water saturated fill material may decrease the settling. Plan on revisiting the site(s) at least once and probably twice to replenish the settled soil.

12rabitat/Cover

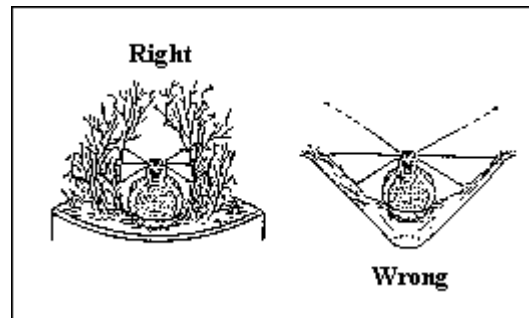

Mallard Nest Basket

This nest basket, similar to the design of a fiberglass goose tub, can be constructed to attract nesting mallards. The frame is made of 1/4" diameter steel rods mounted on 1" diameter steel support pipe. This pipe telescopes inside a 1 1/2" steel pipe with a set screw to establish the desired height. Baskets should be placed in wetlands where water is 2.4 feet deep and where water will remain until at



Hen House

The basic design of the hen house is a three foot long grass cylinder. The hen house is easy to build and all the materials are readily available.

Materials to build a hen house include:

- 7 foot piece of 2" x 2" mesh welded fencing wire 36" wide or 1/4" hardware cloth
- 1" x 6" x 3' treated lumber
- 10 foot long 2" pipe
- wire
- four screws
-

THE UNIVERSITY OF CHICAGO LIBRARY

540 EAST 57TH STREET, CHICAGO, ILL. 60637

TEL: 773-936-3000 FAX: 773-936-3000

WWW.CHICAGO.LIBRARY.EDU

Mourning Dove Nest Basket



Materials: One 12" x 12" piece of hardware cloth.

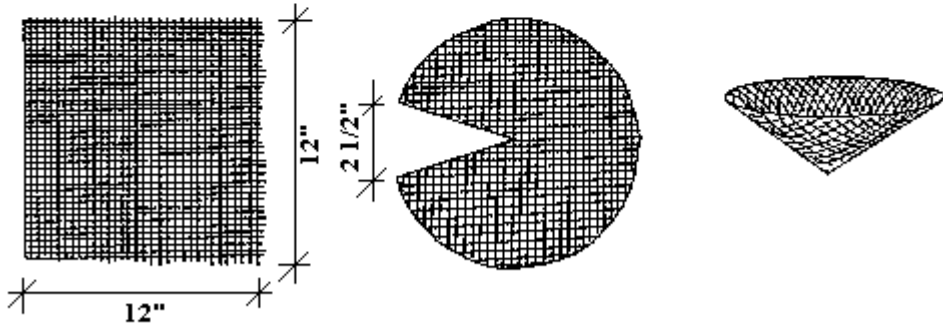

Great Blue Heron Nest Platform

The great blue heron is an elegant water bird found throughout North Dakota. It is most commonly found nesting near rivers, lakes, or other water bodies that contain live wetlands or dead trees. Herons



Entrance Hole Sizes for Duck, Merganser, and

Osprey Nest Boxes (Continued)

Species	Entrance Hole Diameter (inches)
Duck	4.5
Merganser	4.5
Osprey	10.0

Feeders

General Information for Wildlife Feeders

Feeding birds can provide entertainment and enjoyment for people of all ages. You can attract birds to your backyard throughout the year but the most important time to help the birds is during the winter. Cold temperatures and snow limit the food available and put extra demands on birds to keep warm. In the spring and summer, birds feed on insects which are plentiful. Feeding should be restricted to feeders and not simply thrown on the ground.

Once you begin feeding during the winter, don't stop. Birds become dependent on a food source and may not locate an alternative once you stop feeding. There are a variety of seeds and foods that attract birds. The development of black oil sunflower seeds revolutionized bird feeding. It is the single favorite and most nutritious food for birds. Adding specialty foods to feeders will attract even a wider variety of birds. In the summer, for example, sugar water attracts hummingbirds. Fruit brings northern orioles, waxwings, blue jays, and thrashers. Meal worms can lure in bluebirds. In the spring and fall, thistle seed will attract the Harris' sparrow and red-breasted nuthatch. A mixture of black sunflower and thistle attracts evening grosbeaks, red polls, and pine siskens during the winter. Niger thistle attracts purple, house, and goldfinches all year long. Suet will be utilized regularly by woodpeckers, nuthatches, and chickadees.

Placement of your feeder is as important as what feed you put in it. First, consider where you want to watch your birds. Is it by a window, on a glass door, or on the second story? Pick a location that is easily accessible for filling with food and out of the wind. Also consider the mess that empty and spilled seeds will cause below the feeder. Finally, keeping unwanted predators such as stray cats away from your feeder is important. Cats kill millions of songbirds annually and should be prevented from climbing near feeders. Locate your feeder at least 4-5 feet away, from overhanging tree limbs, fencing, or other structures.

This practice may also prevent squirrels from climbing on the feeder. The addition of a predator guard on the support pole may also prevent unwanted visitors. If squirrels still persist at a feeder, lure them to the other side of the yard with an easily accessible tray of peanuts.

Check your feeder for cleanliness if you use a tray or platform type. A dirty feeder may cause disease or discourage birds from coming. If you have trouble attracting birds, try adding a water source. Local bird populations will fluctuate, however, and birds absent for a period of time should not concern you.

Added attractions to your backyard can be lured in with additional types of feeders. The barrel type feeder described is excellent for attracting deer, turkey, pheasants, and cottontail rabbits if filled with corn, sunflower, and oats. You may also attract wood ducks or other waterfowl if you are located in the appropriate area.

2-Liter Plastic Soda Bottle Bird Feeder

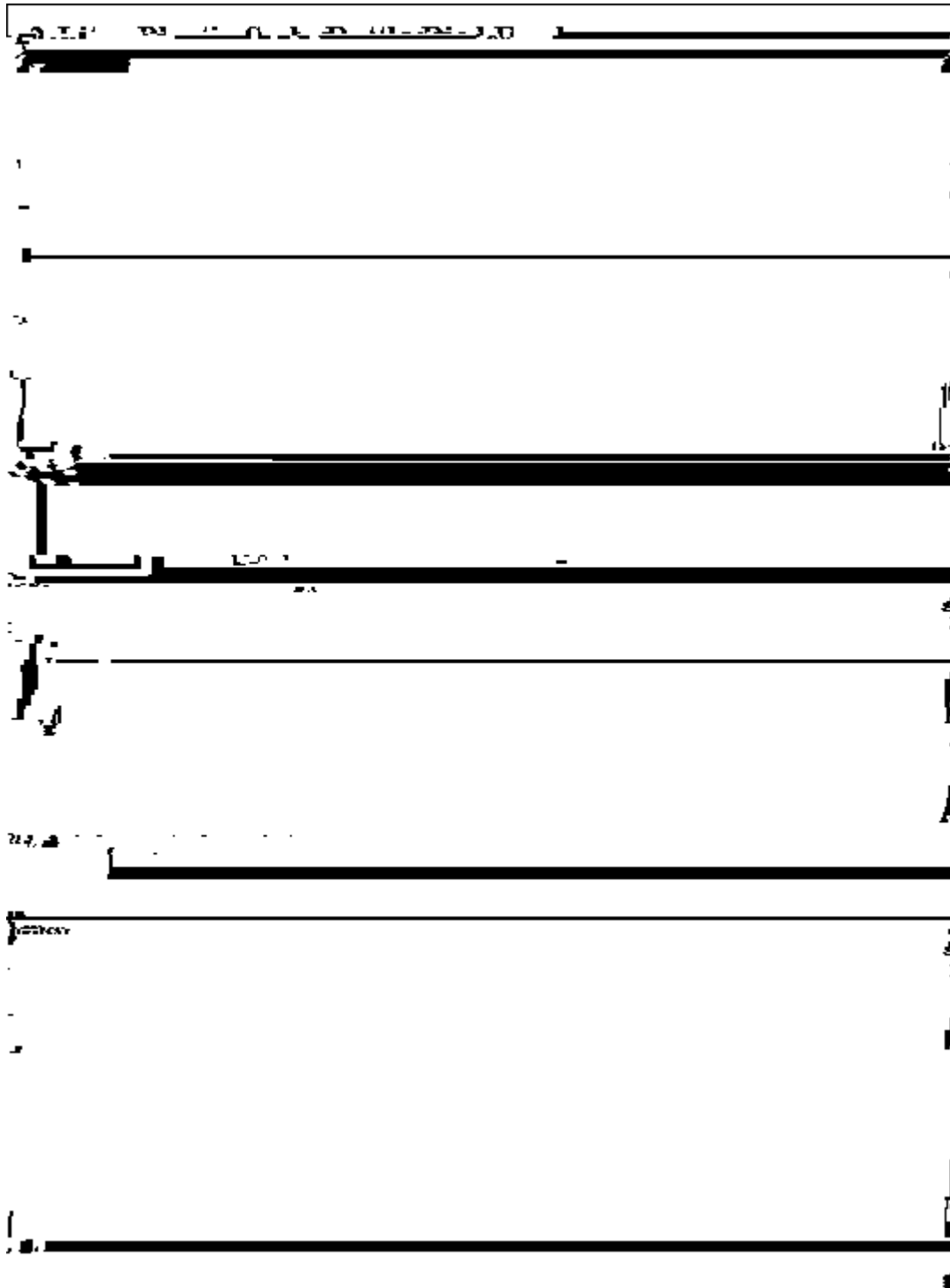

Milk Carton Feeder
by Alice J. Turner

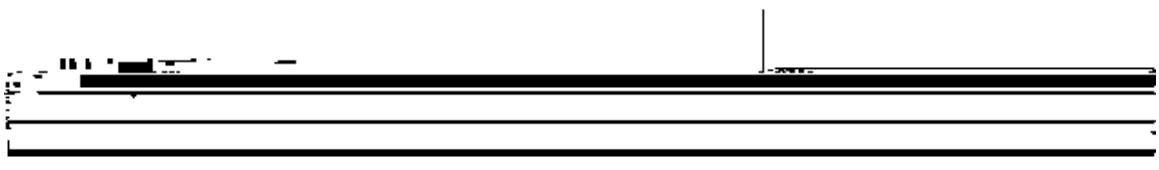
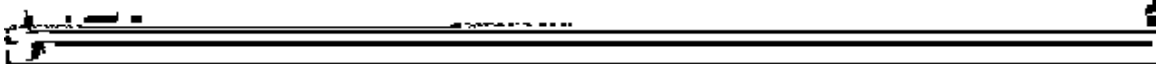
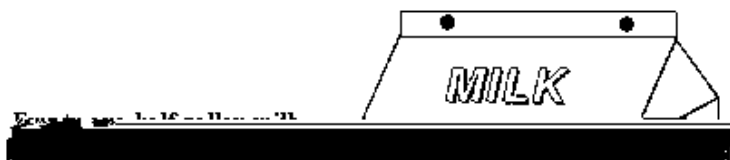

Large Self-Feeder

Ensure all necessary parts and tools are present. (Refer to [Figure 1](#) and hardware list below.)

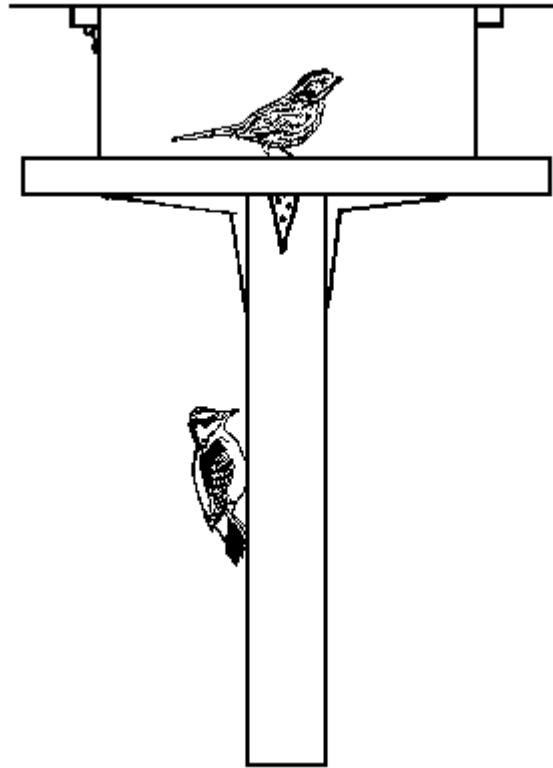

- 2 long brackets
- 2 short brackets
- 12D- 1" x 3/16" bolt/washer/nut assembly
- 2 - 3" hinges
- 2 latch hook assembly
- 48 - 1 5/8" galvanized drywall screws
- 34 - 1" galvanized drywall screws

Attach two roof stops to bottom of roof using three 1" screws per roof stop. Screws should be driven from top of roof (refer to [Figure 3A](#)).

TOOLS REQUIRED

- Table saw
- Philips head screwdriver
- Wrench to tighten bolt assemblies
- Standard screwdriver
- Paint brush/paint
- Post hole digger

Figure 1. Wood required to assemble one Large Winter Bird Feeder

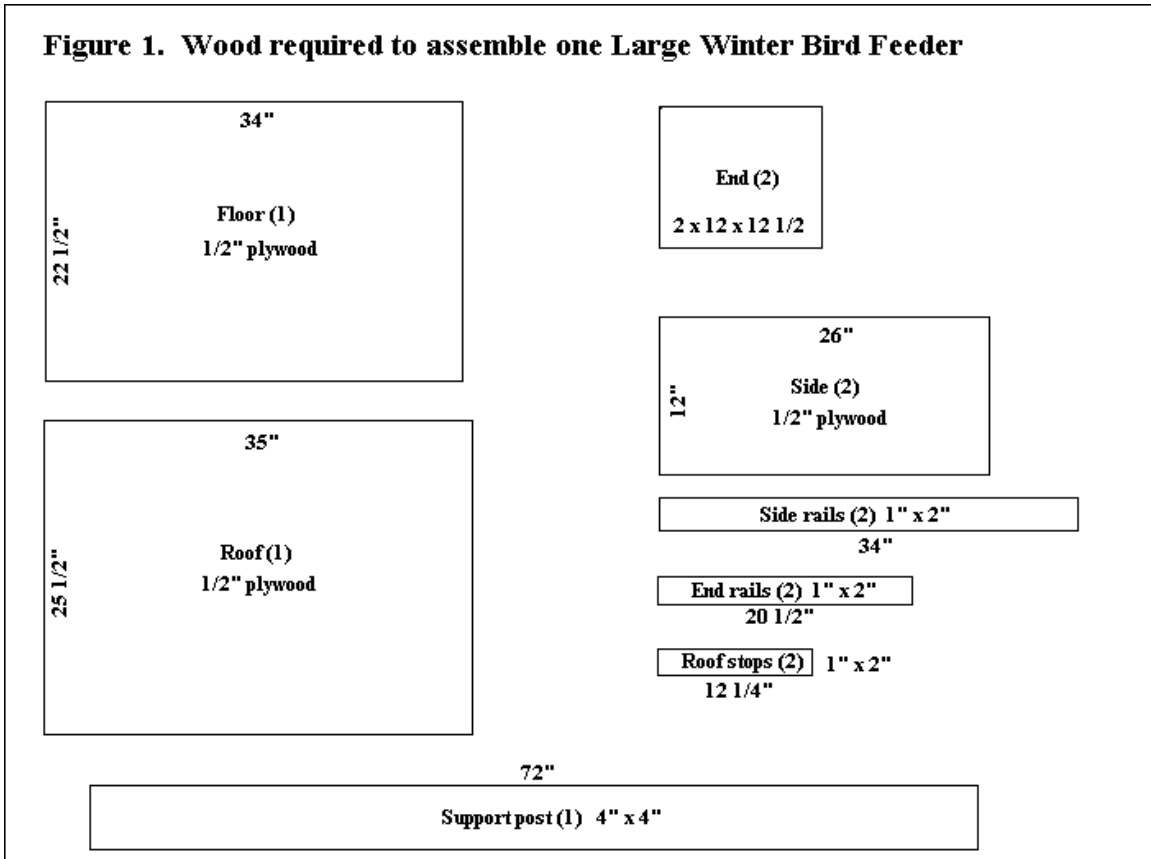
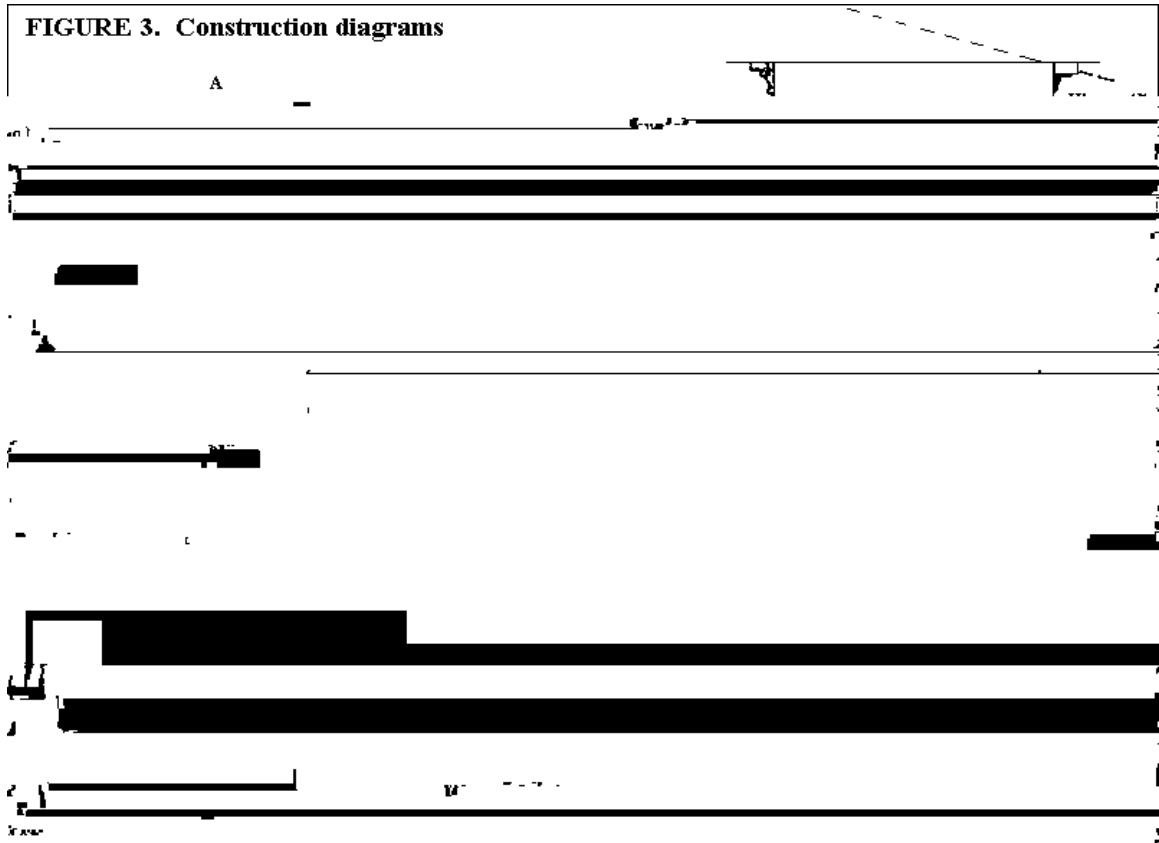
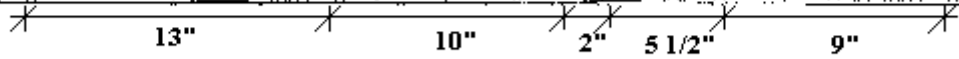
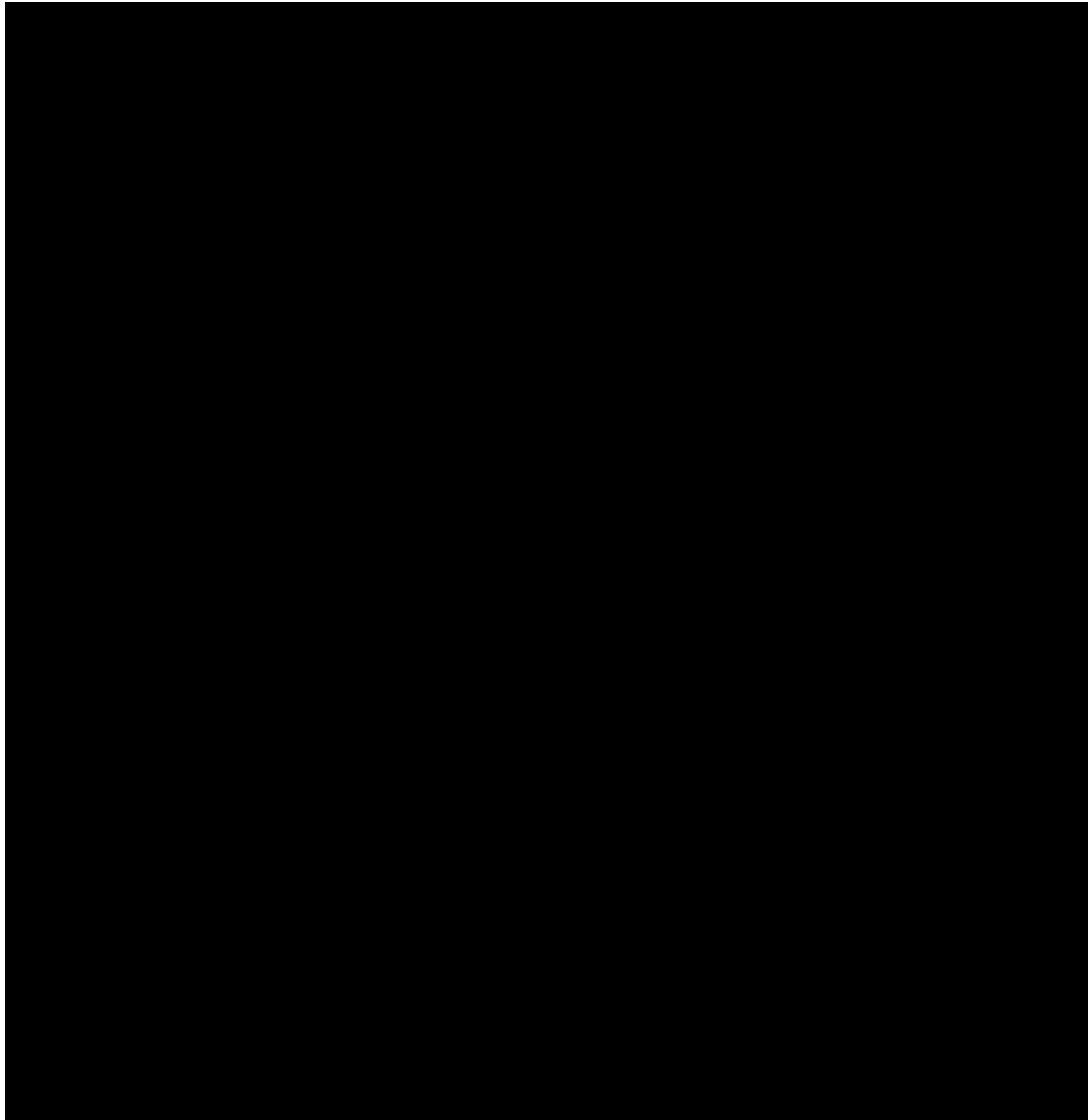



FIGURE 3. Construction diagrams





***If the board is 3/4" thick, the floor must be 5 1/2" x 5 1/2".
If the board is 7/8" thick, the floor must be 5 1/4" x 5 1/4".**

Hardware Cloth Suet Feeder

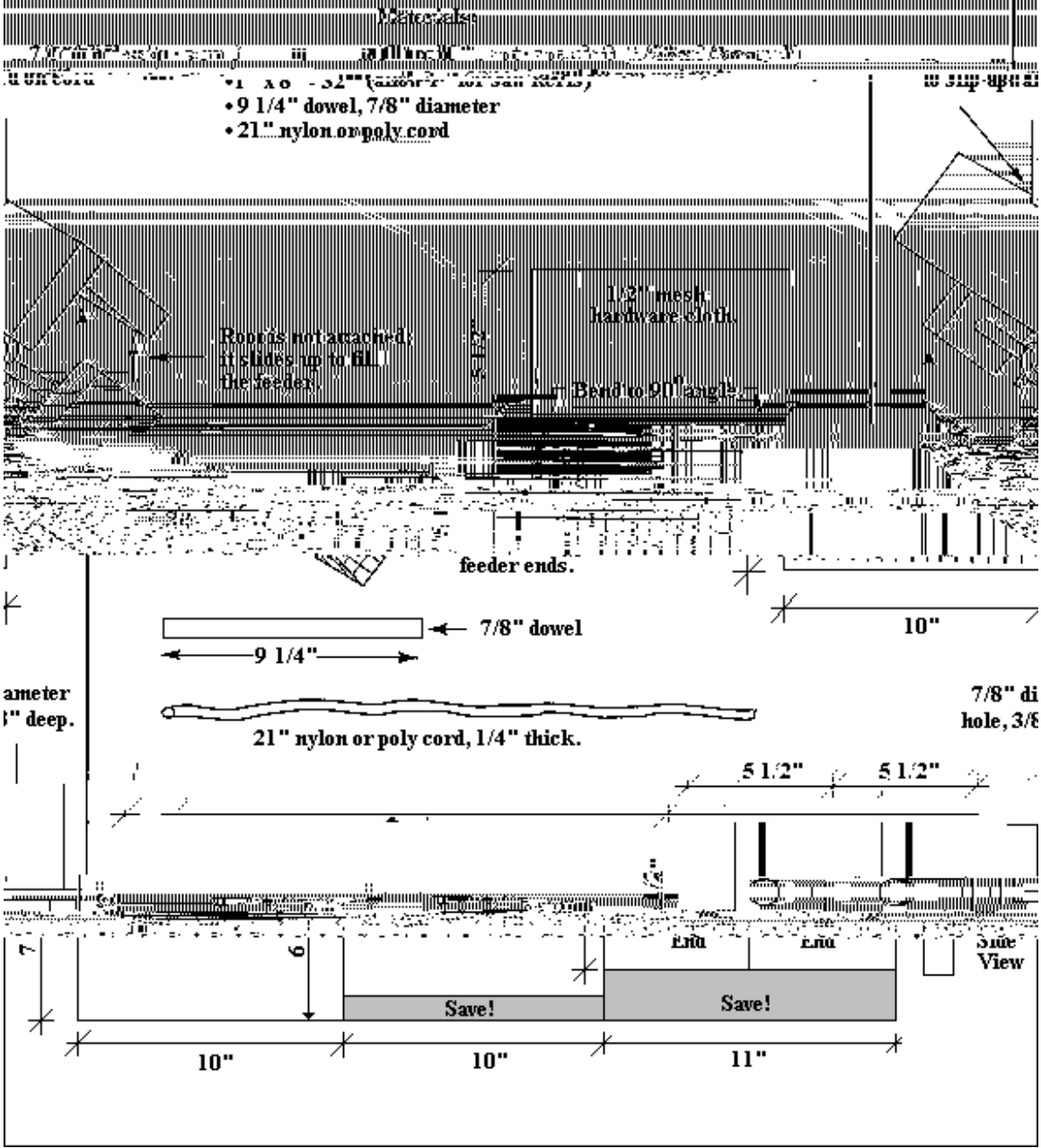

Dowel Suet Feeder

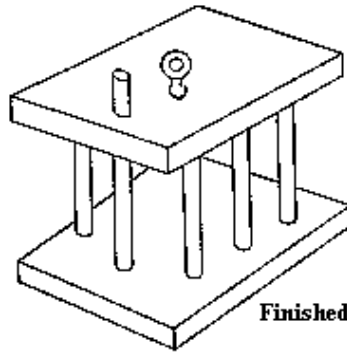

Finished dowel suet feeder.

2" 1 1/2" 1 1/2" 2"



Barrel Feeder for Wildlife

A simple feeder can be constructed from a 55 or 30 gallon steel barrel which can often be acquired for little or no cost. This type of feeder can be filled with any grain including black oil sunflower, corn, oats, or a mixture of grains. It serves as a ground feeder and is excellent for deer, turkeys, and other upland birds.



Instructions

Find a barrel which did not contain pesticides or other toxic chemicals. The barrels most commonly available are those which contained petroleum products. Ensure any residue is washed from the inside of such barrels.

Remove one end of the barrel. This will become the top end into which grain is poured. **Do not** attempt cutting out the end with a cutting torch as vapors within the barrel may be explosive. Instead, use a saber saw with a metal cutting blade or a large hammer and metal cutting chisel.

Make a 12 inch cut lengthwise along the bottom edge of the barrel about 2 inches above the bottom base ring. The cut should be started by first drilling a 3/8 inch hole where the cut will begin. Cut 12 inches across the bottom beginning at the 3/8 inch hole with a saber saw and fine metal cutting blade.

Pound in the metal above the 12 inch cut. The result should be a half-moon shaped opening that will release grain as it is taken from the small tray opening below.

If the barrel did not come with a lid, cut a section of exterior plywood slightly larger than the opening in the top of the barrel. Secure this lid to the barrel using tarp straps. Eye bolts can be fastened to both the barrel and the plywood for points to hook the straps. As an alternate and more simple method, nail three small blocks of wood on the bottom side of the lid just inside the top edge of the barrel and place a brick or other heavy object on top to hold the lid in place.

Predator Guards

"Predator proofing" is an important aspect to consider during the construction phase of bird nest boxes or feeders. This simple step can prevent unwanted predators from destroying eggs or young in a nest box and make your feeder more attractive for wary birds.

All of the predator guards shown below serve the same purpose--to keep predators such as house cats, raccoons, and snakes from scaling the support post to your nest box or feeder. Wood posts are the easiest for predators to climb because they provide a rough surface with a good grip. Metal pipes or posts are less likely to be climbed successfully.

Materials to build predator guards can be made from tin, sheet metal, aluminum, or heavy plastic. A good source of cheap sheeting is often a newspaper office. Aluminum sheets are used to make the impression to print the newspaper and are recycled afterwards.

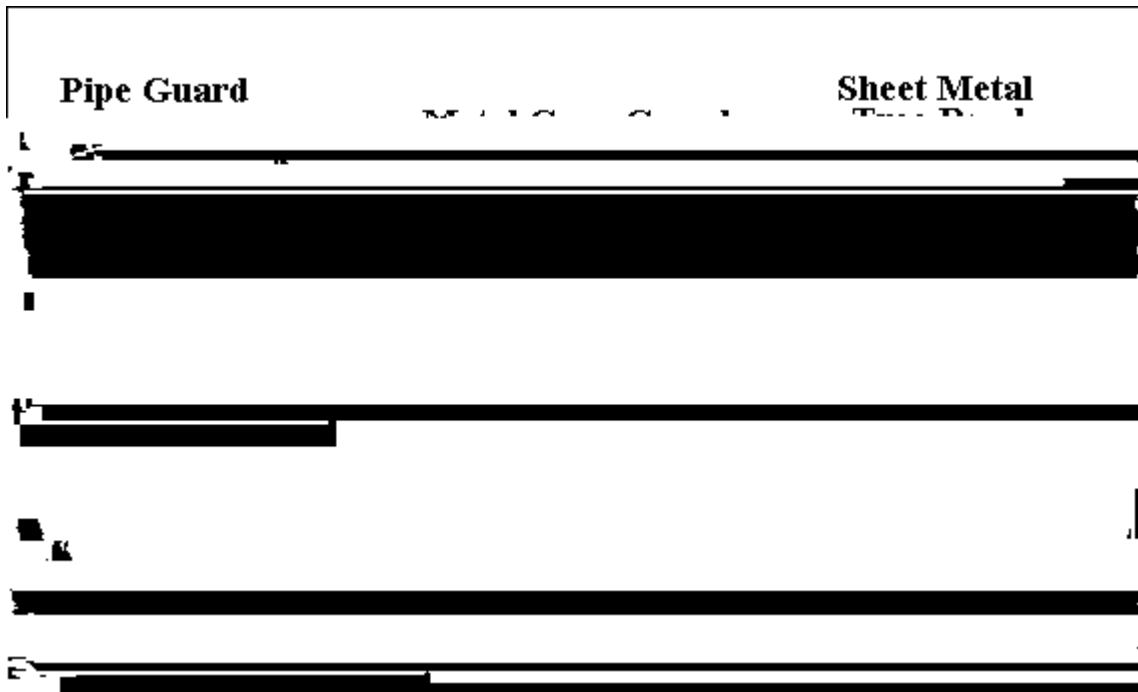

Wildlife Viewing and Photography Blinds

Viewing or photographing wildlife is made easier if you are stationary and let the wildlife come to you. It is easy to attest to that if you've ever fed birds in your back yard at a feeding station. The same approach should be used if you travel out-of-doors to view or photograph wildlife. The fact is that wildlife subjects are just that--wild, and normally won't allow you to approach closely. A little more time will be required to construct, place, and maintain a blind, but the time involved will be far less than the time spent in frustrating pursuit of wary wildlife.

There are as many types and shapes of blinds as there are inventive minds who build them. The main point is that the blind be large enough to make you comfortable, made of dark canvas so light cannot penetrate, and allow your shadow to be seen, made sturdy and anchored to the ground to prevent it from blowing away, and placed in the correct habitat and camouflaged to maximize your chances of seeing wildlife.

Choosing the correct habitat to place the blind is easier and more effective if you know your subjects' habitat and characteristics. Viewing deer, for instance, would require that a blind is placed near a food source where the deer is feeding in the evening, or on a trail that leads from where it feeds to a bedding area where it rests during the day. Another possibility would be a blind near a trail of rubbed trees where a buck frequents in the fall or an area where deer congregate to winter. Every species of wildlife act relatively the same from day to day or season to season and a pattern can usually be established if you do your research.

Other useful tips that may enhance your success include pre-positioning a blind for some time before you plan to use it. Time for the wildlife to get used to the presence of the blind is important. The blind should also be positioned so that the prevailing winds blow from the subject to your blind and not toward the wildlife. Birds are not of concern with this issue. Movement within the blind should be minimal and loud talking prohibited. Bringing a stool or short chair will make the stay more comfortable as patience is often a virtue when sitting in a blind.

Low-Profile A-Frame Blind

Materials Required:

- 4 - 6 (2x2)
- 4 - 2 1/2' (2x2)
- 4 small screws
- 3' of small chain
- 3 - hinges 2" x 3" (with screws)
- Staple gun and 5/8" staples
- 10' x 5' dark canvas
- Carpet knife
- 8 - 2 1/2" wood screws
- Wood glue (optional)

Cut 2x2 material into four 6' lengths and four 2 1/2' lengths. Miter each end with a 45° cut.

Put together with wood screws and glue (for added strength) two rectangular halves each the same size. Let dry.

Add 3 hinges along top edge of blind so halves will fold together like a closed book.

Use a second person to hold halves open to the desired height you wish blind to maintain during use. (The desired angle would likely be close to 90 degrees.) Pick a point half way between the top and bottom of the blind. Use small screws to attach a length of chain to keep blind open in desired position.

Staple canvas to frame. Make sure if canvas is attached while blind is completely open that enough slack material is left to enable folding blind back together.

The canvas at end of the blind can be left loose or tightened by cutting out extra material and stapling to one side.

Cut camera hole in one end only large enough for camera lens to fit through.

Note: This blind is an inexpensive method of gaining concealment for taking wildlife photographs. Since you must lay flat, it is not the best choice for marshy areas where water covering the ground may be a factor. A dense foam sleeping mattress may be helpful to keep you off the ground. A sandbag or beanbag works well to steady your camera or lens. A tall person may need to start with 7' or 7 1/2' 2x2 lengths.

Low - Profile A-Frame Blind

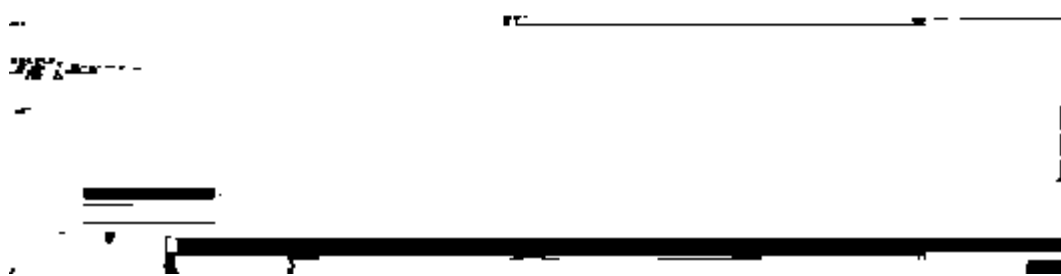
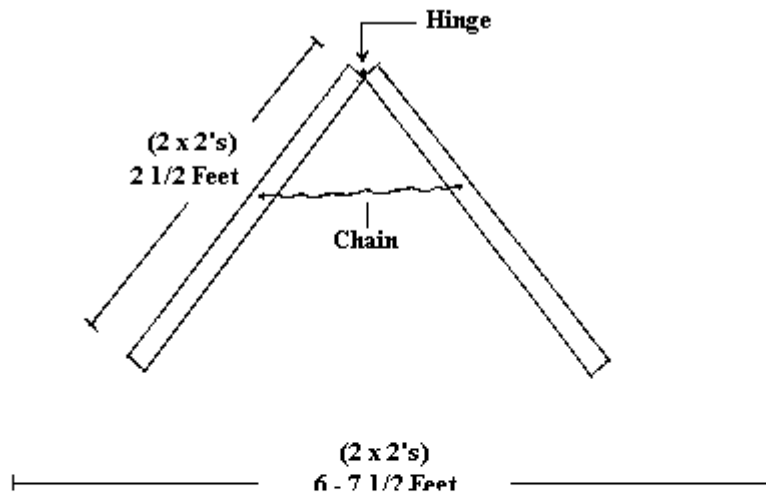

Modified Portable Fishhouse-Type Blind

This blind is fashioned after the typical portable ice house. Finding someone who owns one may give you a head start before construction.

Materials Needed:

- 2 - 4' 1 1/4" (1" x 2")
- 2 - 4' (2" x 4")
- 2 - 5' (2" x 4")
- 2 - (4' x 4') 3/8" plywood
- 7' x 14' dark canvas
- Drill and 1/16" bit, 3/8" bit
- 8' piano hinge
- Jig saw
- 1 box small wood screws (1/2")
- 1 box medium wood screws (3/4")
- Staple gun with 1/2" staples
- Carpet knife
- 8 - 3" wood screws
- Wood glue
- 8 - 4' lengths of 2" x 1/4" lathe

Cut two 4' 2x4s and two 5' 2x4s. Miter ends 90 degrees.

Make base of blind with above 2x4s by joining mitered ends together. Glue and join together with 3" wood screws.

Use piano hinge on inside edge of blind. Attach to each 4' 2x4 one 4x4 sheet of 3/8" plywood. Use 1/2" screws in plywood and 3/4" screws in 2x4. Both plywood pieces should be free to fold toward center of blind.

Begin attaching canvas on one 5' 2x4. Drill pilot holes in lathe material with 1/16" bit. Double canvas over and place lathe material over canvas. Sink 3/4" screws through lathe, canvas, and into 2x4. Have assistant hold both plywood sides straight up.

Stretch canvas over entire blind and repeat above process on opposite 5' 2x4. Cutting of some excess canvas may be necessary.

Secure 1x2s inside blind wedging them between plywood walls. These will be the supports that keep your blind from collapsing. For right now, you may wish to nail them temporarily for ease of working.

Attach canvas on plywood by using lathe and 1/2" screws. Remember doubling canvas and drilling pilot holes. Extra canvas will need to be trimmed. Use your own best judgment, however, canvas should overlap wood by at least 3".

Sit in blind with desired stool to determine level you will be photographing. At this level, trace a hole (with coffee can, etc.) slightly larger than your camera lens. Drill hole with 3/8" bit for a spot to start cutting. You may wish to have camera holes in the canvas also. Make flaps to cover holes by using excess canvas. Use velcro to attach flaps to cover unused windows.

Note: This blind is ideal for situations where water is present since the bottom is entirely open. Wear your rubber boots or use a false floor made of a pallet, etc.

